

LC Field

Fibre Optic Solution

Key Features

- Sealed against Fluids & Dust (IP68)
- Shock, Vibration proof
- 500 mating cycles
- Utilises D38999 Size 19 Shell
- Available with RoHS compliant plating

The LC Field Fibre Optic Connectivity Solution allows you to transform your standard LC patchleads into a ruggedized, environmental connector solution. Utilising the MIL-DTL-38999 Series III Size 19 shell, these connectors offer a tri-start thread with ant-vibration coupling. Designed for use in the most demanding harsh environment and provide the ultimate in reliable performance.

Available in various materials and plating's such as

- Nickel Aluminium Bronze
- Aluminium, Electroless Nickel plated
- Aluminium, Black Zinc Nickel plated (RoHS)

An example of the markets our solutions are used in are:

- Railway
- Base Station
- Military Communications
- Naval Applications

www.foa-ltd.co.uk

sales@foa-ltd.co.uk

Call 01509 881289

Plug

LC Connector (Not supplied unless requested)

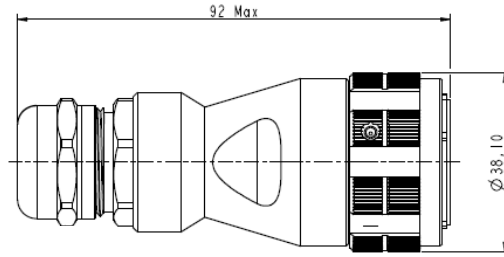
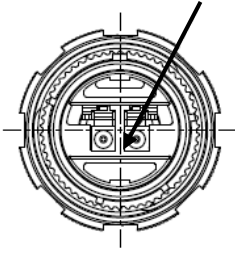

Square Flange Receptacle

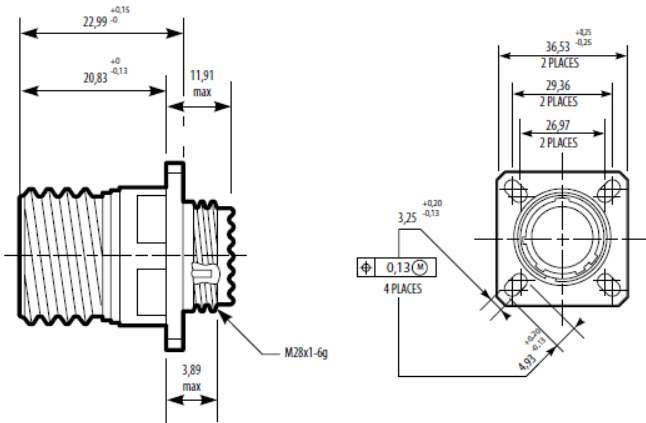

Square flange receptacle rear panel mounting

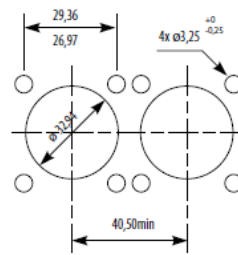

Square flange receptacle front panel mounting

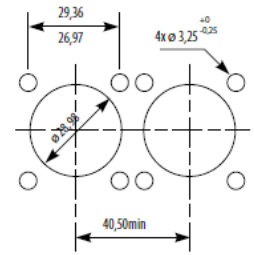

Jam Nut Receptacle

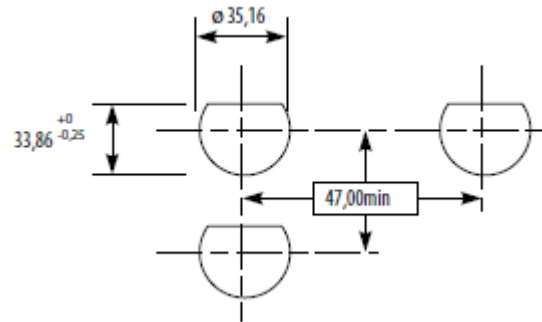
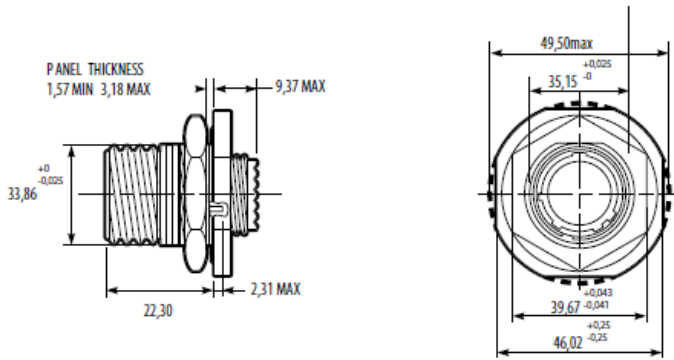

Protective Caps

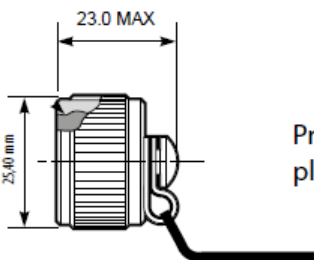

Protective cap for plug (nylon cord)

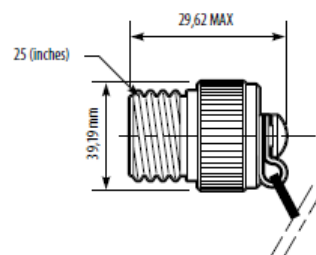

Protective cap for receptacles (nylon cord)

Part Number Code

Series	6M	D	G	N
Connector Type				
Shell Type				
Plug(Compatible with all LC PC and APC Duplex)				
6M: Plug with metal backshell and metal PG clamp				
2: Square Flange Receptacle for LC PC				
2A: Square Flange Receptacle for APC				
7: Jam Nut Receptacle for LC PC				
7A: Jam Nut Receptacle for LC APC				
Cable Type (Plug Only)				
D: Flat duplex cable 1.6mm				
E: Duplex zipcord 1.6mm				
F: Flat duplex cable 2mm				
G: Duplex zipcord 2mm				
H: Flat duplex cable 2.8mm				
I: Duplex zipcord 2.8mm				
T: Flat duplex cable + Duplex zipcord for 1.6mm – 2mm – 2.8mm				
Only for receptacle (no backshell available for receptacle)				
O: Receptacle without backshell				
Shell Finish				
N: Nickel plated				
G: Olive drab cadmium plated				
B: Nickel Aluminium Bronze				
ZN: Black Zinc Nickel (RoHS Compliant)				
Polarization				
N: Normal or A, B, C, D, E				

Cap Series	B	EC	N	TV	W	19
Protective Cap Type						
EC: Square Flange Receptacle						
ER: Jam Nut Receptacle						
F: Plug						
Wire type						
N: Nylon Cord						
Blank: Metallic chain						
TV: Series						
Shell Finish						
N: Nickel plated						
W: Olive drab cadmium plated						
B: Nickel Aluminium Bronze						
ZN: Black Zinc Nickel (RoHS Compliant)						
Shell Size: 19						

We can provide complete assemblies.
Contact us with your requirements.

Tooling

Mounting Tool
LCFTV MO TOOL

Dismounting Tool
LCFTV DM TOOL

www.foa-ltd.co.uk
sales@foa-ltd.co.uk
 Call 01509 881289